

$V_{DS} = 1200\text{ V}$

$I_D(T_C=25^\circ\text{C}) = 41\text{ A}$

$R_{DS(on),typ} = 80\text{ m}\Omega @ V_{GS}=20\text{ V}$

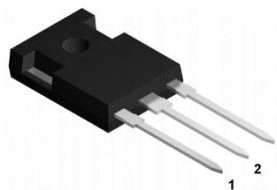

TO-247-3

Features

- Wide bandgap SiC MOSFET technology
- Low On-Resistance with High Blocking Voltage
- Low Capacitances with High-Speed switching
- Low reverse recovery(Qrr)
- Halogen free, RoHs compliant

Benefits

- Reduce switching losses
- Increased system Switching Frequency
- Increased power density
- Reduction of heat sink requirements

Applications

- Switch mode power supplies
- Renewable energy
- Motor drives
- High voltage DC/DC converters

Package Pin Definitions

- Pin1- Drain
- Pin2- Power Source
- Pin3- Kelvin Source
- Pin4- Gate

Package Parameters

Part Number	Marking	Package
SMC80N120T3BS	SMC80N120T3BS	TO-247-3

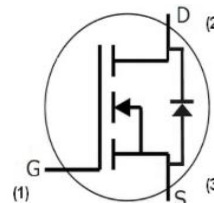

Maximum Ratings ($T_C=25^\circ\text{C}$ unless otherwise specified)

Symbol	Parameter	Test conditions	Value	Unit	Note
V_{DSmax}	Drain-Source Voltage	$V_{GS} = 0V, I_D = 100\mu A$	1200	V	
V_{GSmax}	Gate-Source voltage	AC ($f > 1\text{ Hz}$)	-10/+25	V	
V_{GSop}	Recommend Gate-Source Voltage	Static	-5/+20	V	
I_D	Continuous Drain current	$V_{GS} = 20V, T_C = 25^\circ\text{C}$	41	A	Fig. 14
		$V_{GS} = 20V, T_C = 100^\circ\text{C}$	28		
$I_{D,pulse}$	Pulsed Drain Current	Pulse with t_p limited by T_{jmax}	80	A	Fig. 18
P_D	Power Dissipation	$T_C = 25^\circ\text{C}, T_j = 175^\circ\text{C}$	208	W	Fig. 16
T_j	Operating junction temperature		-55~150	$^\circ\text{C}$	
T_{stg}	Storage temperature		-55~150	$^\circ\text{C}$	
	TO-247 mounting torque	M3 Screw	0.7	Nm	

Thermal Characteristics

Symbol	Parameter	Value			Unit	Note
		Min.	Typ.	Max.		
$R_{th(jc)}$	Thermal resistance from Junction to Case		0.72		K/W	Fig. 15
$R_{th(ja)}$	Thermal resistance from Junction to Ambient		40			

Electrical Characteristics $T_j=25^\circ\text{C}$ unless otherwise specified

Static Characteristics

Symbol	Parameter	Test conditions	Value			Unit	Note
			Min.	Typ.	Max.		
$V_{(BR)DSS}$	Drain-Source Breakdown voltage	$V_{GS} = 0V, I_D = 100\mu A$	1200			V	
$V_{GS(th)}$	Gate Threshold voltage	$V_{GS} = V_{DS}, I_D = 5mA$		3.0		V	Fig. 9
		$V_{GS} = V_{DS}, I_D = 5mA, T_j = 175^\circ\text{C}$		2.3			
I_{GSS}	Gate-Source Leakage current	$V_{GS} = 20V, V_{DS} = 0V$			250	nA	
I_{DSS}	Zero Gate Voltage Drain Current	$V_{DS} = 1200V, V_{GS} = 0V, T_j = 25^\circ\text{C}$		1	50	μA	
$R_{DS(on)}$	Drain-Source On-state Resistance	$V_{GS} = 20V, I_D = 20A$		80	98	m Ω	Fig. 3, 4, 5
		$V_{GS} = 20V, I_D = 20A, T_j = 175^\circ\text{C}$		130			
g_{fs}	Transconductance	$V_{GS} = 20V, I_D = 20A$		9		S	Fig. 6
		$V_{GS} = 20V, I_D = 20A, T_j = 175^\circ\text{C}$		7			

Gate Charge Characteristics

Symbol	Parameter	Test conditions	Value			Unit	Note
			Min.	Typ.	Max.		
Q_{GS}	Gate to Source Charge	$V_{DS} = 800V$ $I_D = 20A$ $V_{GS} = -5V/20V$		15		nC	Fig. 10
Q_{GD}	Gate to Drain Charge			30			
Q_G	Total Gate Charge			66			

AC Characteristics ($T_J=25^\circ C$ unless otherwise specified)

Symbol	Parameter	Test conditions	Value			Unit	Note
			Min.	Typ.	Max.		
C_{iss}	Input Capacitance	$V_{GS} = 0V, V_{DS} = 1000V$ $f = 1\text{ MHz}$ $V_{AC} = 25mV$		1374		pF	Fig. 13
C_{oss}	Output Capacitance			63		pF	
C_{rss}	Reverse Transfer Capacitance			3.5		pF	
$R_{G(int)}$	Internal Gate Resistance	$f = 1\text{ MHz}, V_{AC} = 25mV$		2		Ω	

Reverse Diode Characteristics ($T_j=25^\circ\text{C}$ unless otherwise specified)

Symbol	Parameter	Test conditions	Value			Unit	Note
			Min.	Typ.	Max.		
V_{SD}	Diode Forward Voltage	$V_{GS} = -4\text{V}, I_{SD} = 10\text{A}$		3.7		V	Fig. 7,8
		$V_{GS} = -4\text{V}, I_{SD} = 10\text{A}, T_j = 175^\circ\text{C}$		3.1			
I_S	Continuous Diode Forward Current	$V_{GS} = -4\text{V}, T_C = 25^\circ\text{C}$		35		A	
$I_{S, pulse}$	Diode pulse Current	$V_{GS} = -4\text{V}$, pulse width t_p limited by T_{jmax}		80		A	

Typical Performance

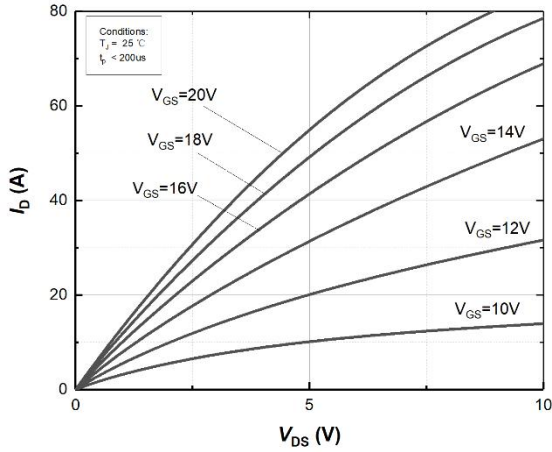

Figure 1. Output characteristics at $T_j=25^\circ\text{C}$

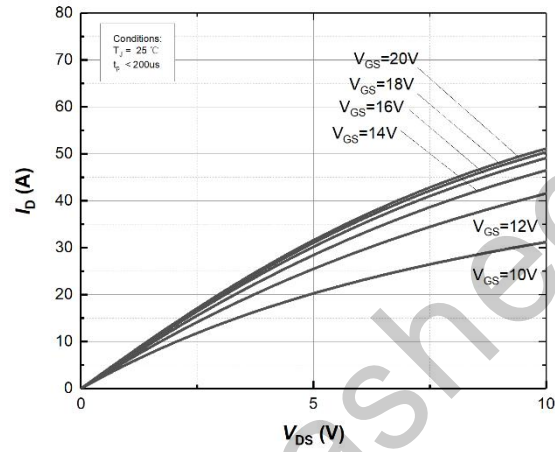

Figure 2. Output characteristics at $T_j=175^\circ\text{C}$

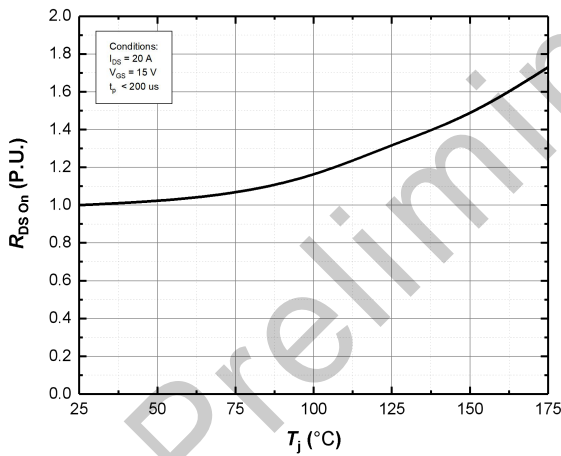

Figure 3. Normalized On-Resistance vs. Temperature

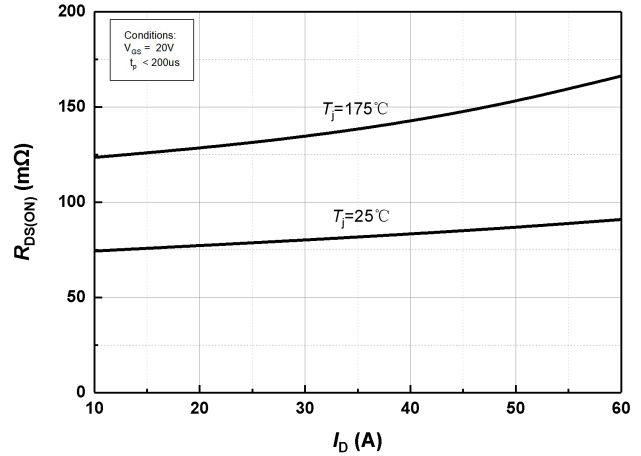

Figure 4. On-Resistance vs. Drain current for Various Temperature

Typical Performance

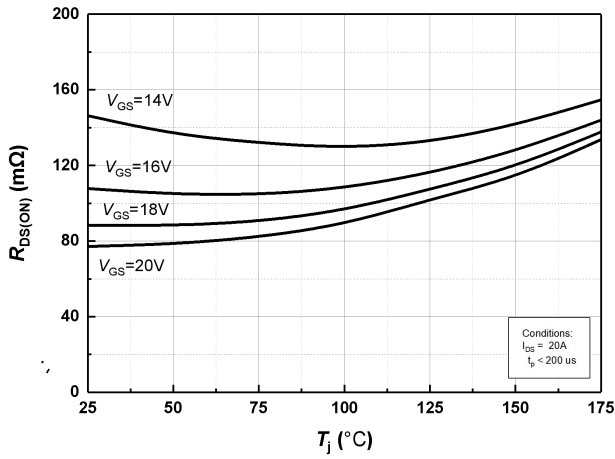

Figure 5. On-Resistance vs. Temperature for Various Gate Voltage

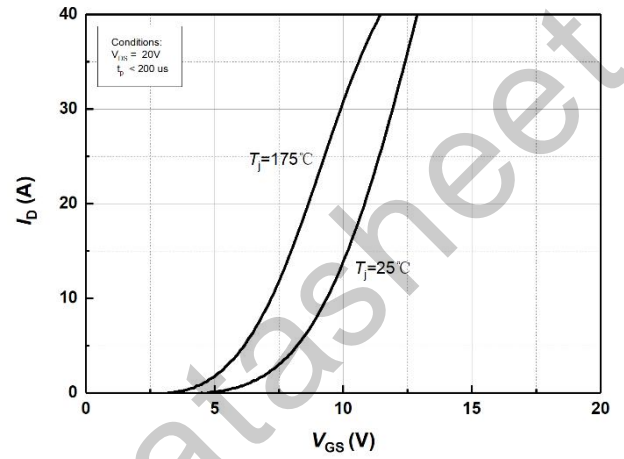

Figure 6. Transfer Characteristics for Various Junction Temperatures

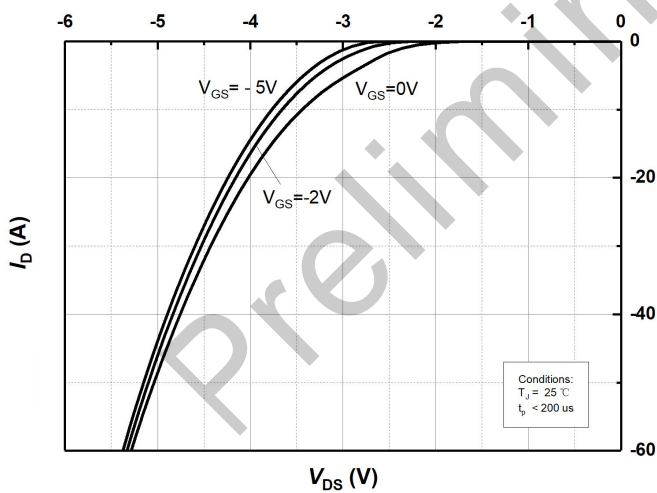

Figure 7. Body Diode Characteristics at Tj=25°C

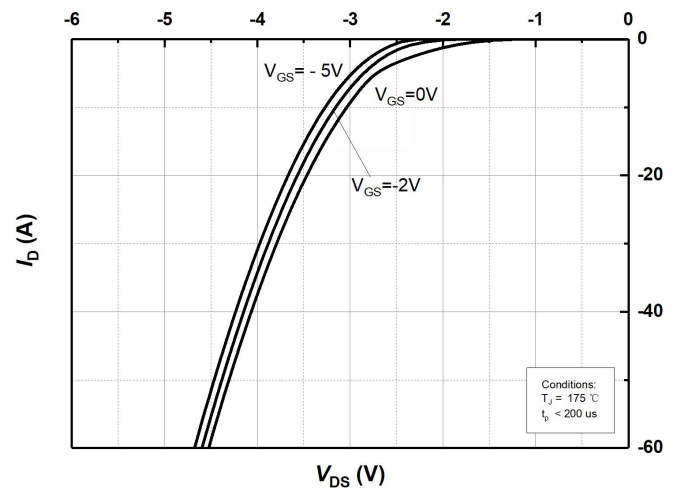

Figure 8. Body Diode Characteristics at Tj=175°C

Typical Performance

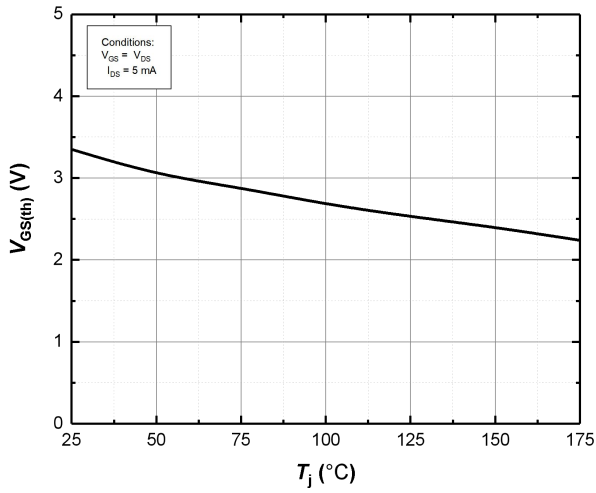

Figure 9. Threshold Voltage vs. Temperature

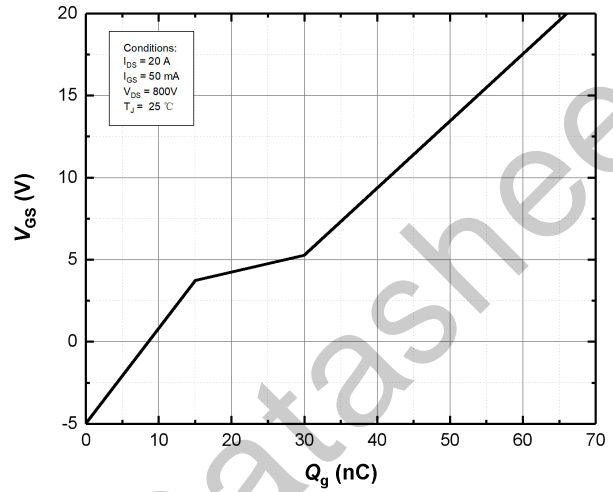

Figure 10 Gate Charge Characteristics

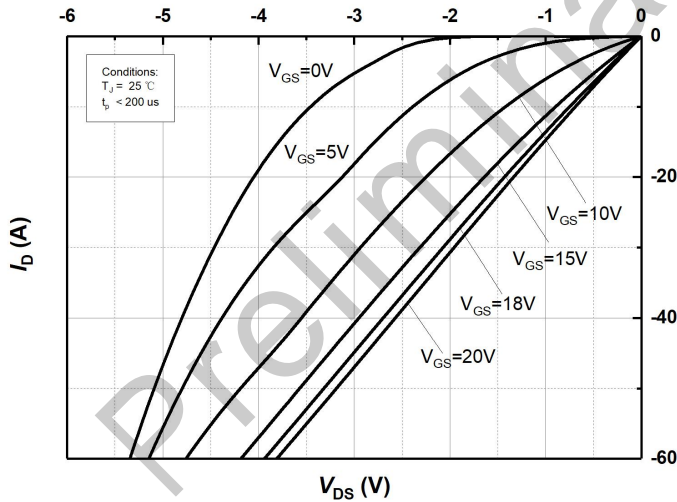

Figure 11. 3rd Quadrant Characteristic at T_j=25°C

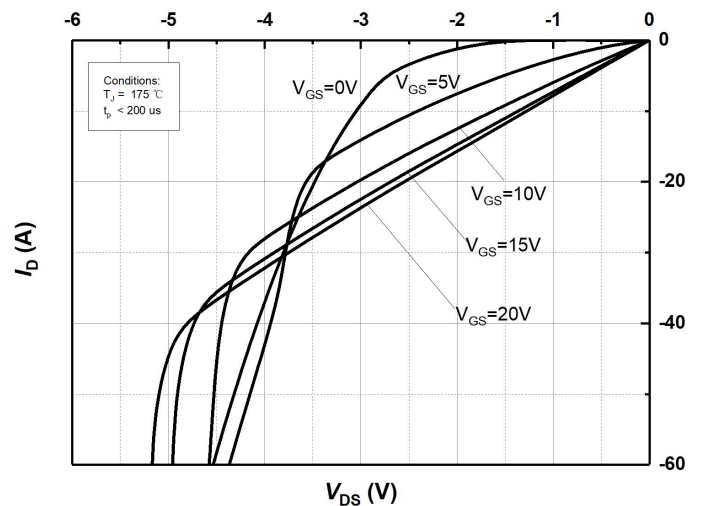

Figure 12. 3rd Quadrant Characteristic at T_j=175°C

Typical Performance

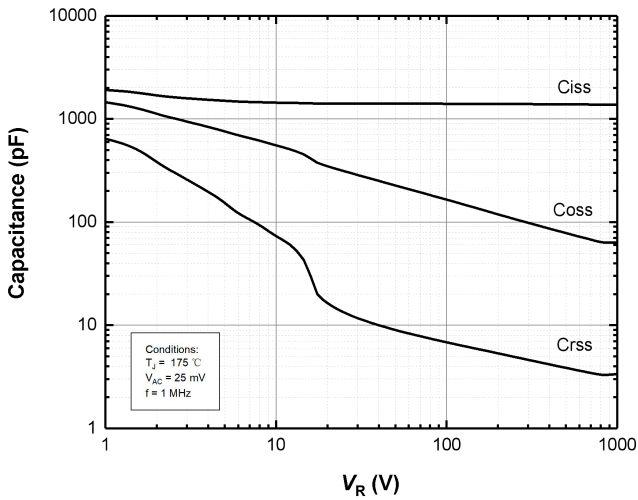

Figure 13. Capacitances vs. Drain-Source Voltage (0 – 1000V)

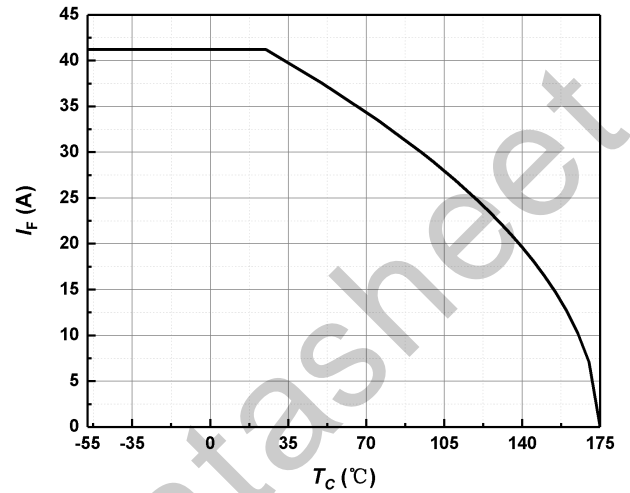

Figure 14. Continuous Drain Current Derating vs Case Temperature

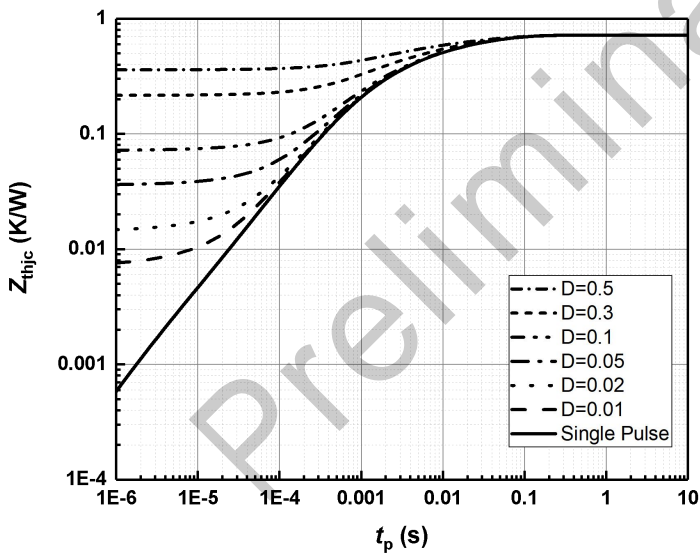

Figure 15. Transient Thermal Impedance (Junction – Case)

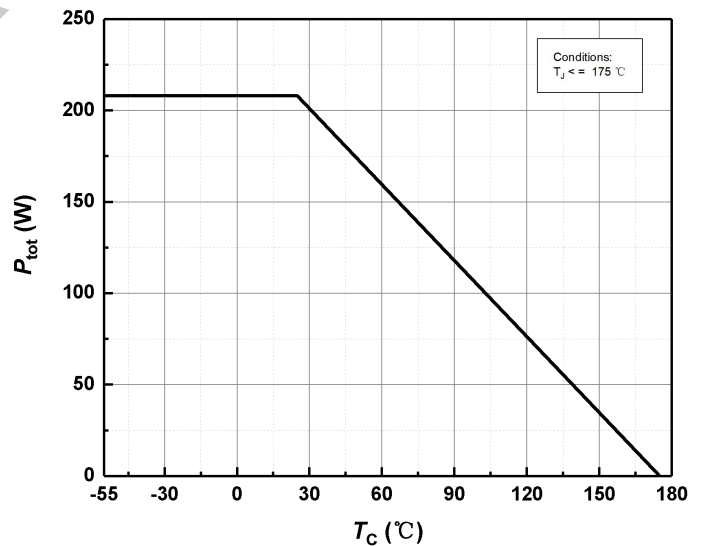

Figure 16. Maximum Power Dissipation Derating vs. Case Temperature

Typical Performance

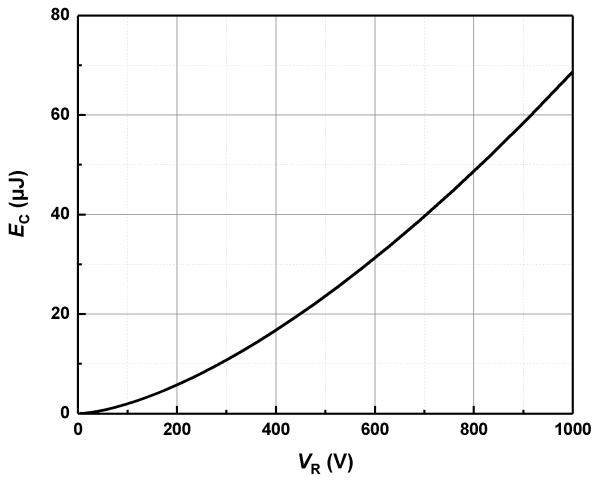

Figure 17. Output Capacitor Stored Energy

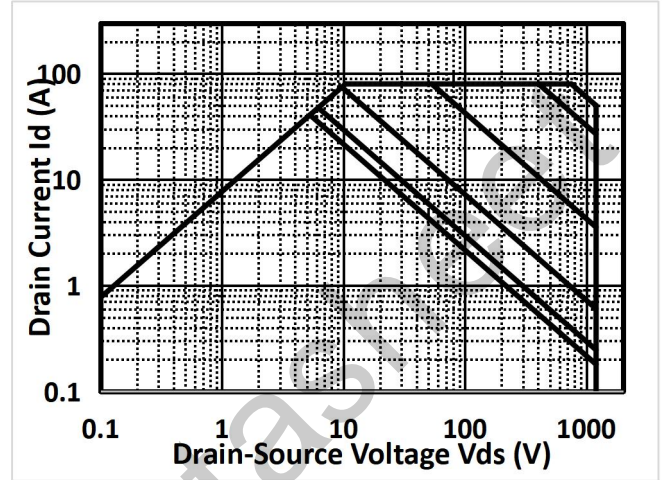
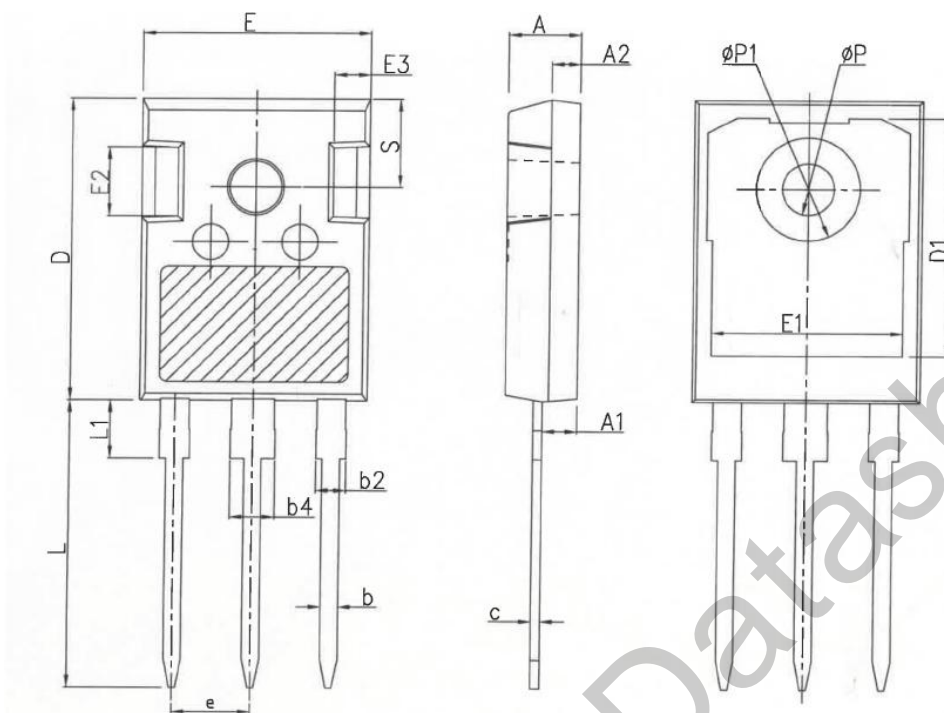

Figure 18. Safe Operating Area

Preliminary Data

Package Dimensions



SYMBOL	MM		
	MIN	NOM	MAX
A	4.80	5.00	5.20
A1	2.21	2.41	2.59
A2	1.85	2.00	2.15
b	1.11	1.21	1.36
b2	1.91	2.01	2.21
b4	2.91	3.01	3.21
c	0.51	0.61	0.75
D	20.70	21.00	21.30
D1	16.25	16.55	16.85
E	15.50	15.80	16.10
E1	13.00	13.30	13.60
E2	4.80	5.00	5.20
E3	2.30	2.50	2.70
e	5.44BSC		
L	19.62	19.92	20.22
L1	NA	NA	4.30
ΦP	3.40	3.60	3.80
ΦP1	NA	NA	7.30
S	6.15BSC		

Revision History

Document Version	Date of Release	Description of Changes
Rev 1.0	2022-11-01	Release of the datasheet.

SiCred Microelectronics Co.,Ltd
Shenzhen, China
© 2022 SiCred Ltd.
All Rights Reserved.

Information

For further information on technology, delivery terms and conditions and prices, please contact the nearest SiCred Office

Disclaimer

The information given in this document shall in no event be regarded as a guarantee of conditions or characteristics. With respect to any examples or hints given herein, any typical values stated herein and/or any information regarding the application of the device, SiCred Ltd. hereby disclaims any and all warranties and liabilities of any kind, including without limitation, warranties of non-infringement of intellectual property rights of any third party.